

1



2

3

4

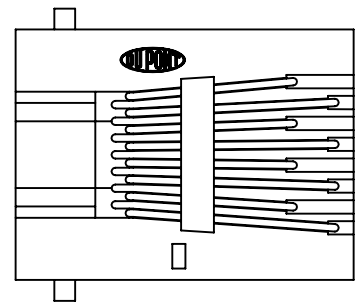
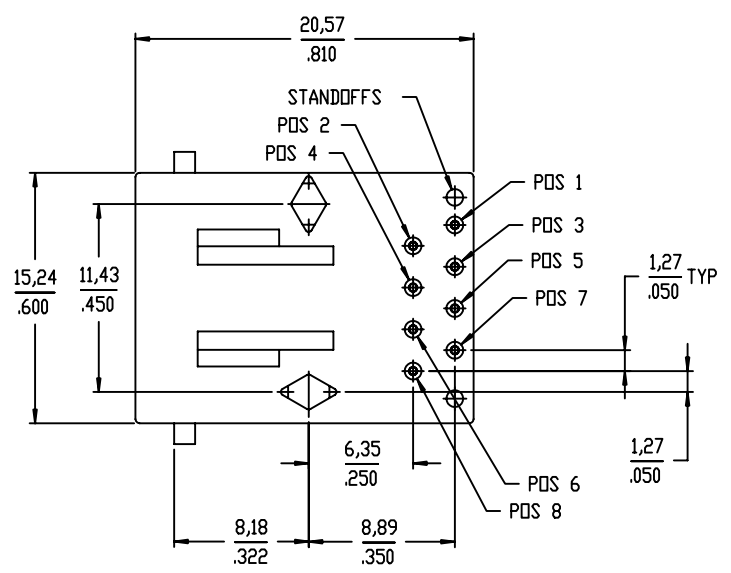
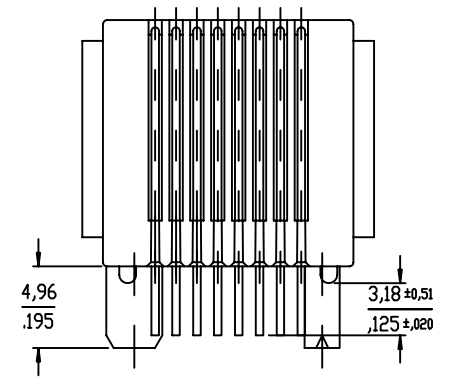
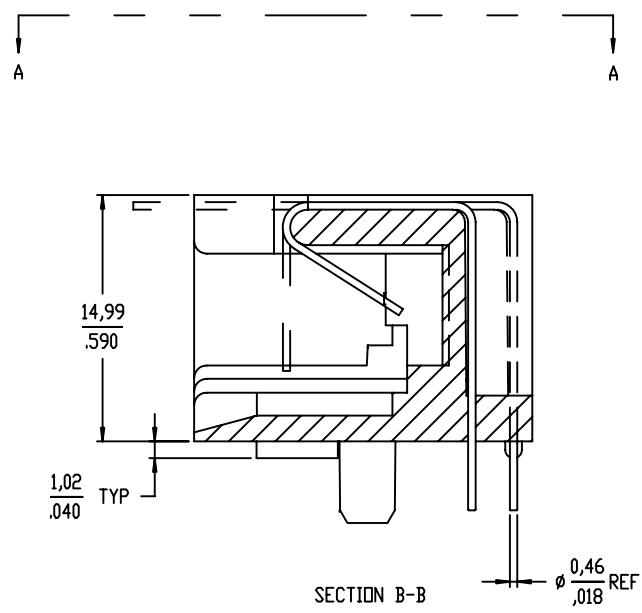
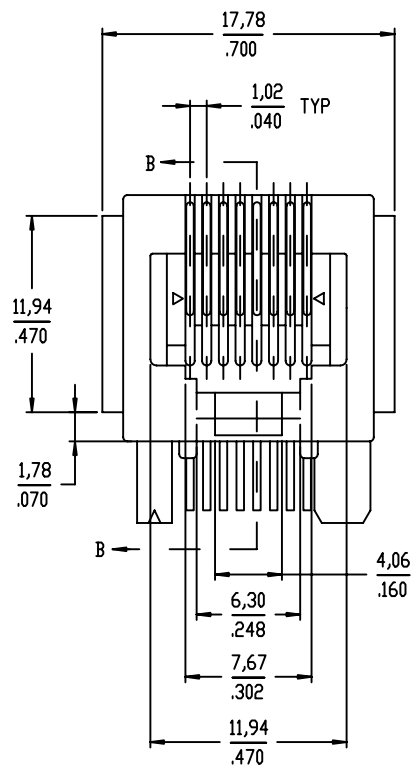
REV	DESCRIPTION	REV'D BY	DATE
M	REDRAWN ECR S20252	ERIC C.	08/09/92
N	ECR S60061	BC LDH	08MAR.96
P	ECR S80059	BC LDH	09MAR.98
R	ECR V80855	R.MARSHALL	15JUN.98
S	ECR V91508	B.BRUBAKER	18NOV.99
T	ECR S00022	BC LDH	26JAN.00
U	ECR V10424	B.BRUBAKER	12FEB.01
V	ECR N05-0002	YS	06JAN.01
w	ECR N08-0074	MIAD SH	30APR.08



GEN. TOLERANCES		DO NOT SCALE DWG.	
X.X ±0.3 / X.XX ±0.1		MM	
X.XX ±0.13 / X.XXX ±0.05		 	
X.XXX ±0.051 / X.XXXX ±0.020			
ANGLES ± 2°0'			
DRAWN	JANET	DATE	15JUN.98
CHECKED	M CHENG	DATE	19FEB.01
APPROVED	M CHENG	DATE	19FEB.01

FCJ

DESCRIPTION

8 POS HORIZONTAL
P.C.B. MOD JACK ASSY

PRODUCT NO. 68899

SCALE 3 : 1 SHT 1 OF 3

CUSTOMER COPY

1

2

3

4

REV
L
M
N
P
R
S
T
U
V

RECOMMENDED BOARD LAYOUT
VIEWED FROM TOP

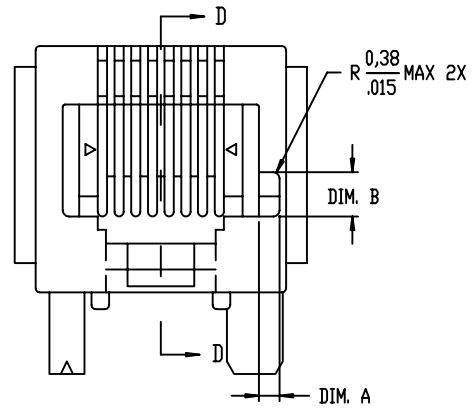
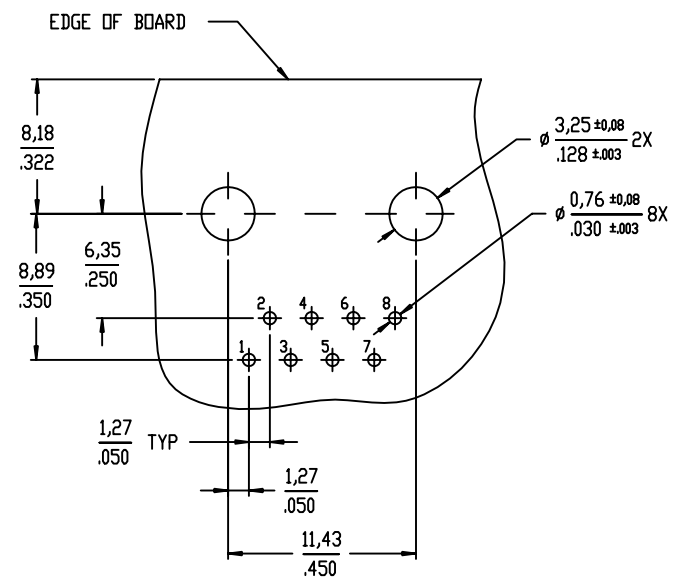

KEYED STYLE

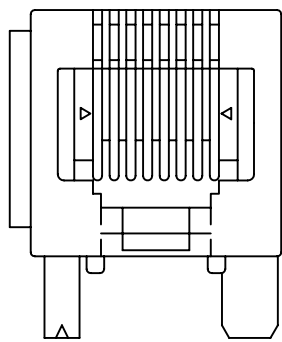

LEFT EAR MOUNTING

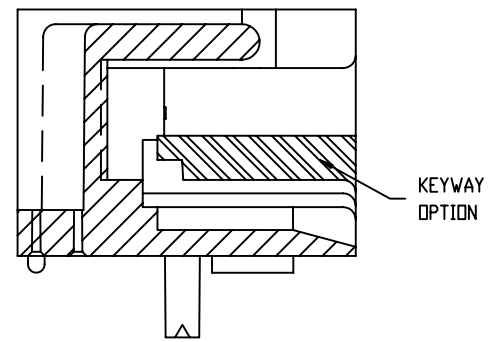

SECTION D-D

- NOTE :
- 1 GXT IS 0,76um / 30u" MIN GXT WITH Au FLASH OVER 1,27um / 50u" MIN Ni.
 - 2 THIS PRODUCT MEETS EUROPEAN UNION DIRECTIVES AND OTHER COUNTRY REGULATIONS AS DESCRIBED IN GS-22-008.
 - 3 THE HOUSING WILL WITHSTAND EXPOSURE TO 260°C PEAK TEMPERATURE FOR 10 SECONDS IN A WAVE SOLDER APPLICATION WITH A 1.60mm MINIMUM THICK CIRCUIT BOARD.
 - 4 IF LF P/N PACKAGING MEETS GS-14-920 SPECIFICATION.

BY

GEN. TOLERANCES		DO NOT SCALE DWG.			
X.X ±0.3 / X.XX ±.01 X.XX ±0.13 / X.XXX ±.005 X.XXX ±0.051 / X.XXXX ±.0020 ANGLES ± 2°0'		MM 			DESCRIPTION
		NAME	DATE	8 POS HORIZONTAL P.C.B. MOD JACK ASSY	
DRAWN	JANET	15JUN.98		PRODUCT NO.	68899
CHECKED	M CHENG	19FEB.01		SCALE	3 : 1
APPROVED	M CHENG	19FEB.01		SHT	2 OF 3

CUSTOMER COPY

PRODUCT NO.	DIM. A	DIM. B	STYLE	POSITIONS LOADED	CONTACT PLATING	HOUSING COLOR	MOUNTING EARS	REMARKS	REV
68899-001 -001LF	-	-	UNKEYED	ALL	GXT	BLACK	YES	-	L
-002 -002LF	1,25 /,050	2,69 /,106	KEYED	ALL	GXT	BLACK	YES	-	M
-003 -003LF	-	-	UNKEYED	2,3,4,5,6,7	GXT	BLACK	YES	-	N
-004 -004LF	-	-	UNKEYED	ALL	GXT	BLACK	NO	-	P
-004RLF	-	-	UNKEYED	ALL	GXT	RED	NO	-	R
-004GLF	-	-	UNKEYED	ALL	GXT	GREEN	NO	-	S
-005 -005LF	-	-	UNKEYED	ALL	GXT	GRAY	NO	-	T
-006 -006LF	-	-	UNKEYED	ALL	0,76um /30*u Au	BLACK	YES	-	U
-007 -007LF	1,25 /,050	2,69 /,106	KEYED	ALL	GXT	BLACK	NO	-	V
-008 -008LF	-	-	UNKEYED	ALL	GXT	BLACK	LEFT ONLY	-	
-009 -009LF	-	-	UNKEYED	ALL	GXT	BLACK	RIGHT ONLY	-	
-010 -010LF	-	-	UNKEYED	ALL	1,27um /50*u Au	BLACK	YES	-	
-011 -011LF	-	-	UNKEYED	1,4,5,8	GXT	BLACK	YES	-	
-012 -012LF	-	-	UNKEYED	ALL	0,76um /30*u Au	BLACK	NO	-	
-013 -013LF	-	-	UNKEYED	ALL	1,27um /50*u Au	BLACK	NO	-	
-014 -014LF	1,25 /,050	2,69 /,106	KEYED	ALL	0,76um /30*u Au	BLACK	NO	-	
-015 -015LF	1,25 /,050	2,69 /,106	KEYED	ALL	1,27um /50*u Au	BLACK	NO	-	

LEAD FREE PRODUCT NO.

CUSTOMER COPY

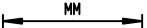
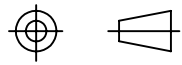
GEN. TOLERANCES		DO NOT SCALE DWG.		
X.X ±0.3 / X.XX ±0.1 X.XX ±0.13 / X.XXX ±0.05 X.XXX ±0.051 / X.XXXX ±0.020 ANGLES ± 2°0'				
				DESCRIPTION 8 POS HORIZONTAL P.C.B. MOD JACK ASSY
	NAME	DATE		
DRAWN	JANET	15 JUN.98		PRODUCT NO. 68899 SCALE 3 : 1 SHT <u>3</u> OF <u>3</u>
CHECKED	M CHENG	19 FEB.01		
APPROVED	M CHENG	19 FEB.01		

PDM: Rev:W

STATUS: Released

Printed: May 15, 2008